

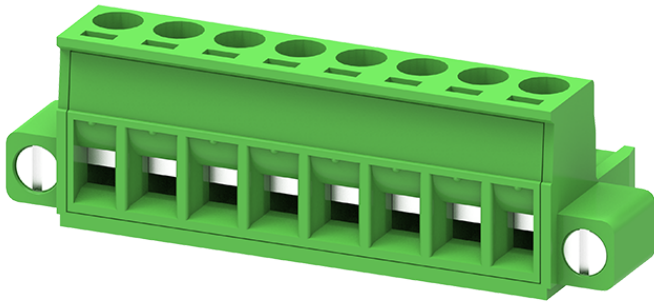

Product Type: Plug-in terminal-Plug

Product Name:MC-RB5.0H10C-K-0001

Product Description: Pitch:5.0mm Rated Voltage : 320V Rated Current:18A Connection method : Screw connection colour : customizable



Product Size

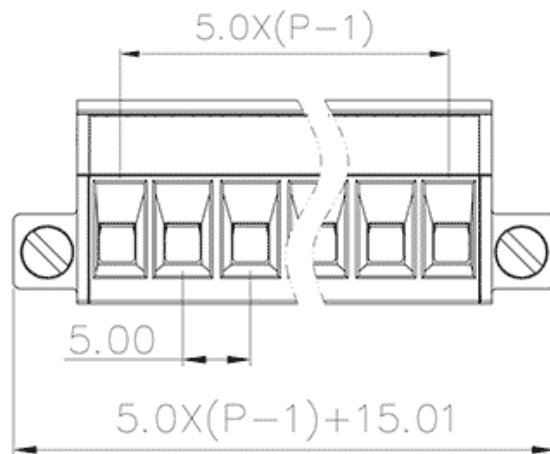
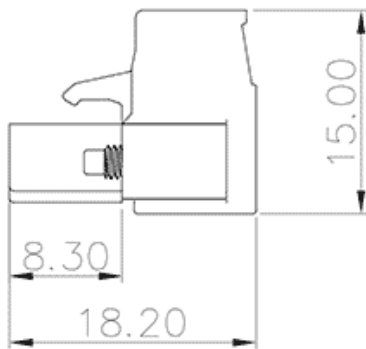

Parameters

<input checked="" type="checkbox"/> SUPU ID	MC-RB5.0H10C-K-0001
<input checked="" type="checkbox"/> Pitch	5
<input checked="" type="checkbox"/> Number of levels	single layer
<input checked="" type="checkbox"/> Number of connections	10

<input type="checkbox"/> Connection method	Screw connection
<input type="checkbox"/> Protection Level	IP20
<input type="checkbox"/> Operating temperature range	-40~+105°C
<input type="checkbox"/> Insulation material	PA66
<input type="checkbox"/> Insulation material group	I
<input type="checkbox"/> Contact material	Copper alloy
<input type="checkbox"/> Contact plating	Sn,Plated
<input type="checkbox"/> Color	Green/Black/Blue/Grey/Orange/Red

Technical data

<input type="checkbox"/> IEC Rated Current	18A
<input type="checkbox"/> IEC Rated Voltage	320V
<input type="checkbox"/> Overvoltage category	III/III/ II
<input type="checkbox"/> Degree of pollution	3 2 2
<input type="checkbox"/> Rated impulse voltage	4.0KV 4.0KV4.0KV
<input type="checkbox"/> UL Rated Current	15A - 10A
<input type="checkbox"/> UL Rated Voltage	250V 320V 630V
<input type="checkbox"/> Conductor cross section rigid	0.2-2.5mm ²
<input type="checkbox"/> Conductor cross section flexible	0.2-2.5mm ²
<input type="checkbox"/> Conductor cross section flexible,with ferrule	0.2-2.5mm ²
<input type="checkbox"/> Locking screw Specification	M3
<input type="checkbox"/> Locking screw torque	0.5-0.6N.m
<input type="checkbox"/> Fixed Screw Specification	M2.5
<input type="checkbox"/> 固定螺钉扭矩	0.3N.m

<input type="checkbox"/> Stripping length	7-8mm
<input type="checkbox"/> Use group	B/C/D
<input type="checkbox"/> Rated cross section	24~12AWG

Commercial data

<input type="checkbox"/> Order No	MC-RB5.0H10C-K-0001
-----------------------------------	---------------------

Ningbo SUPU Electronics Co., Ltd.

Address: No. 150, Xinxing 4th Road, High-tech Industrial Development Zone,

Cixi City, Zhejiang Province, China

Zip code: 315303

Switchboard: +86 574-63288158

Fax: +86 574-63288170

E-mail:supucontact@supu.cn

Service Hotline: 400-626-6336



Wechat