

Product Type: Plug-in terminal-Socket

Product Name:MC-PJ5.08H05P-F-0001

Product Description: Pitch: 5.08mm Rated Voltage : 320V Rated Current: 12A Connection method : Push-in spring connection colour : customizable

Product Size

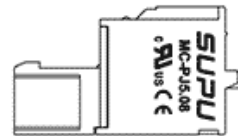
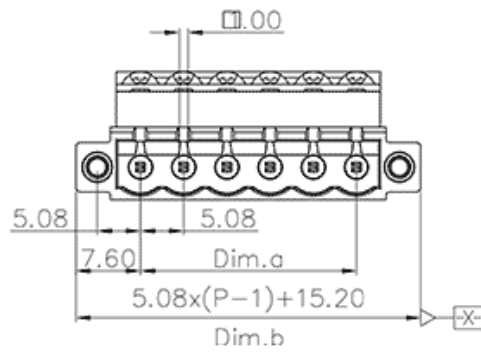
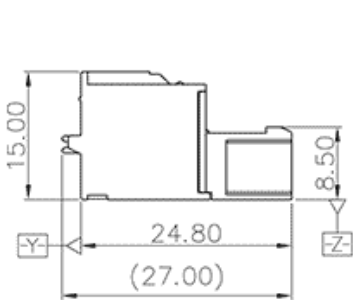
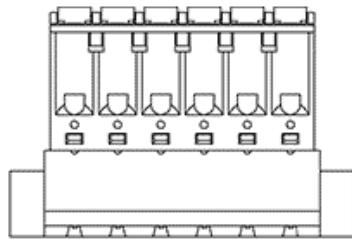

Parameters

<input checked="" type="checkbox"/> SUPU ID	MC-PJ5.08H05P-F-0001
<input checked="" type="checkbox"/> Pitch	5.08
<input checked="" type="checkbox"/> Number of levels	Single layer
<input checked="" type="checkbox"/> Number of connections	5

<input type="checkbox"/> Connection method	Push in connection
<input type="checkbox"/> Protection Level	IP20
<input type="checkbox"/> Operating temperature range	-40~+105°C
<input type="checkbox"/> Insulation material	PA66
<input type="checkbox"/> Insulation material group	I
<input type="checkbox"/> Contact material	Copper alloy
<input type="checkbox"/> Contact plating	Sn,Plated
<input type="checkbox"/> Color	Green/Black/Blue/Grey/Orange/Red

Technical data

<input type="checkbox"/> IEC Rated Current	320V
<input type="checkbox"/> IEC Rated Voltage	12A
<input type="checkbox"/> Overvoltage category	III III II
<input type="checkbox"/> Degree of pollution	3 2 2
<input type="checkbox"/> Rated impulse voltage	4.0KV 4.0KV 4.0KV
<input type="checkbox"/> UL Rated Current	10A - 10A
<input type="checkbox"/> UL Rated Voltage	300V - 300V
<input type="checkbox"/> Conductor cross section rigid	0.2-2.5mm ²
<input type="checkbox"/> Conductor cross section flexible	0.2-2.5mm ²
<input type="checkbox"/> Conductor cross section flexible,with furrule	0.2-2.5mm ²
<input type="checkbox"/> Stripping length	10~11mm
<input type="checkbox"/> Use group	B/C/D
<input type="checkbox"/> Rated cross section	24~12AWG

Commercial data

Ningbo SUPU Electronics Co., Ltd.

Address: No. 150, Xinxing 4th Road, High-tech Industrial Development Zone,
Cixi City, Zhejiang Province, China

Zip code: 315303

Switchboard: +86 574-63288158

Fax: +86 574-63288170

E-mail: supucontact@supu.cn

Service Hotline: 400-626-6336

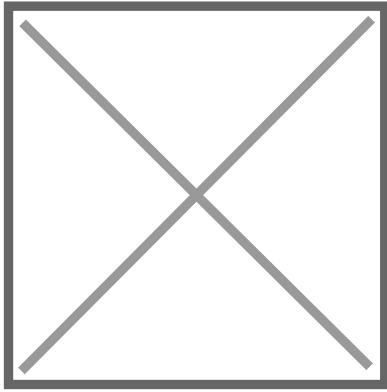

Wechat