

Product Type: Plug-in terminal-Plug

Product Name:MC-DRF3.5H24P-K-0001

Product Description: Pitch:3.5mm Rated Voltage : 160V Rated Current:8A Connection method : Push in connection colour : customizable

Product Size

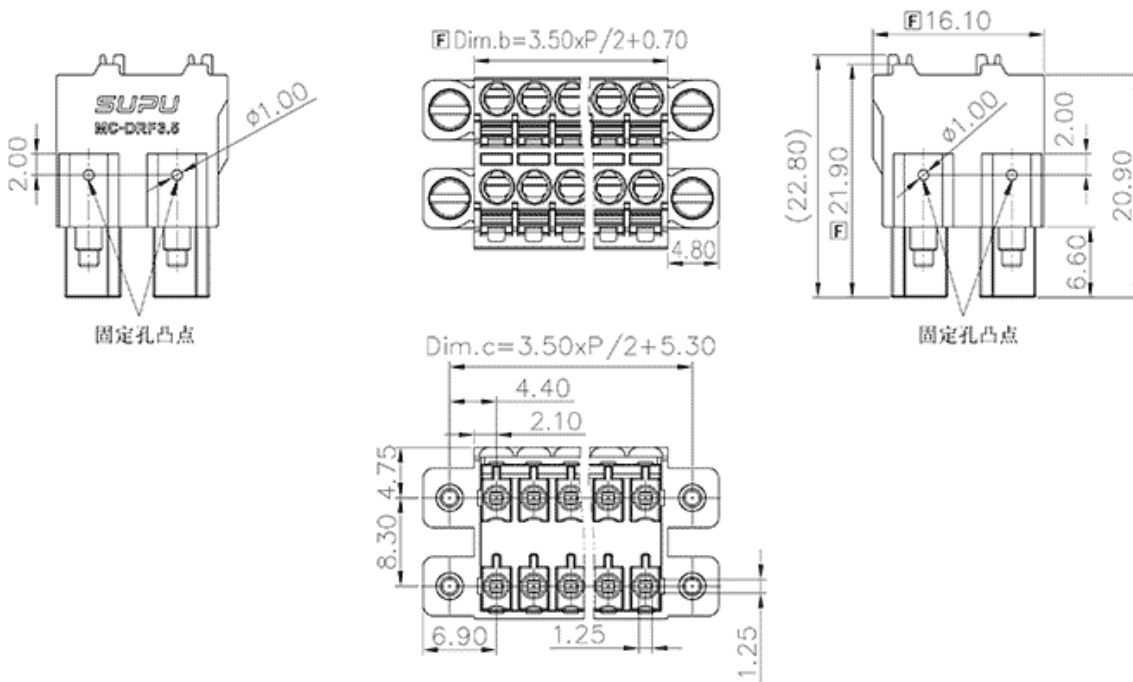

Parameters

<input checked="" type="checkbox"/> SUPU ID	MC-DRF3.5H24P-K-0001
<input checked="" type="checkbox"/> Pitch	3.5
<input checked="" type="checkbox"/> Number of levels	double-layer
<input checked="" type="checkbox"/> Number of connections	24

<input type="checkbox"/> Connection method	Push in connection
<input type="checkbox"/> Protection Level	IP20
<input type="checkbox"/> Operating temperature range	-40~+105°C
<input type="checkbox"/> Insulation material	PA66
<input type="checkbox"/> Insulation material group	I
<input type="checkbox"/> Contact material	Copper alloy
<input type="checkbox"/> Contact plating	Sn,Plated
<input type="checkbox"/> Color	Green/Black/Blue/Grey/Orange/Red

Technical data

<input type="checkbox"/> IEC Rated Current	8A
<input type="checkbox"/> IEC Rated Voltage	160V
<input type="checkbox"/> Overvoltage category	III/III/II
<input type="checkbox"/> Degree of pollution	3 2 2
<input type="checkbox"/> Rated impulse voltage	2.5KV 2.5KV 2.5KV
<input type="checkbox"/> UL Rated Current	8A - -
<input type="checkbox"/> UL Rated Voltage	300V - -
<input type="checkbox"/> Conductor cross section rigid	0.2-1.5mm ²
<input type="checkbox"/> Conductor cross section flexible	0.2-1.5mm ²
<input type="checkbox"/> Conductor cross section flexible,with ferrule	0.2-1.5mm ²
<input type="checkbox"/> Locking screw Specification	-
<input type="checkbox"/> Locking screw torque	-
<input type="checkbox"/> Fixed Screw Specification	M2.5
<input type="checkbox"/> 固定螺钉扭矩	0.3N.m

<input type="checkbox"/> Stripping length	10mm
<input type="checkbox"/> Use group	B/C/D
<input type="checkbox"/> Rated cross section	24~16AWG

Commercial data

<input type="checkbox"/> Order No	MC-DRF3.5H24P-K-0001
-----------------------------------	----------------------

Ningbo SUPU Electronics Co., Ltd.

Address: No. 150, Xinxing 4th Road, High-tech Industrial Development Zone,

Cixi City, Zhejiang Province, China

Zip code: 315303

Switchboard: +86 574-63288158

Fax: +86 574-63288170

E-mail:supucontact@supu.cn

Service Hotline: 400-626-6336



Wechat