

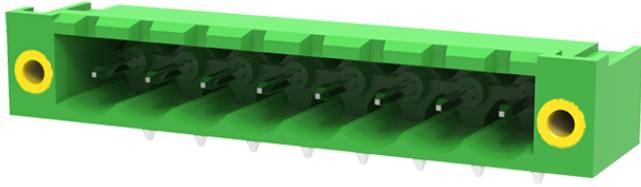

Product Type: Plug-in terminal-socket

Product Name:MC-PA5.0H04-F-0002



Product Description: Pitch: 5.0mm Rated Voltage : 320V Rated Current: 18A colour : customizable

Product Size

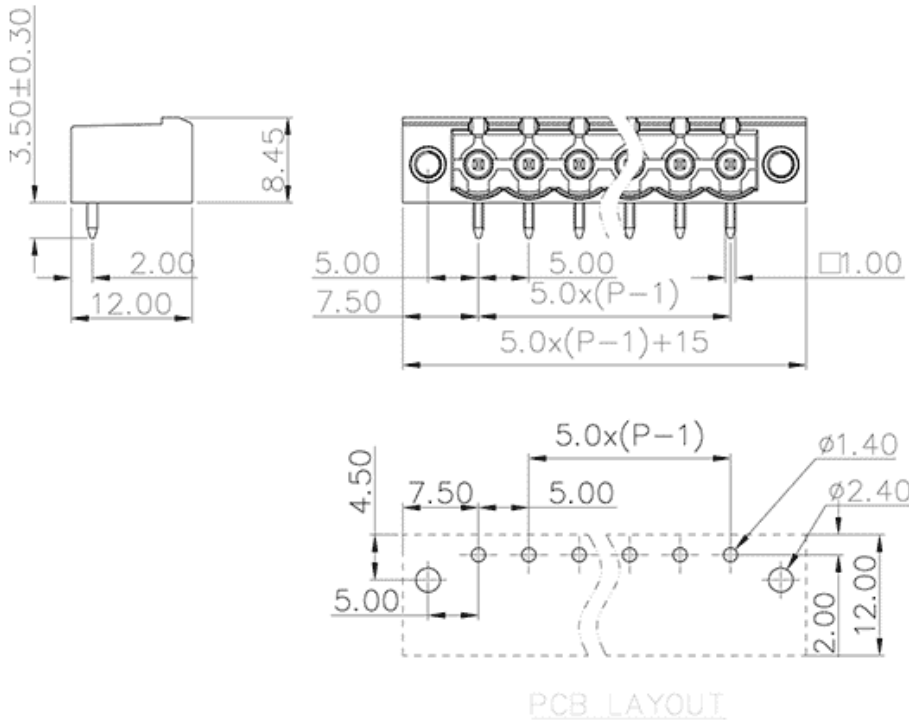

Parameters

<input checked="" type="checkbox"/> SUPU ID	MC-PA5.0H04-F-0002
<input checked="" type="checkbox"/> Pitch	5
<input checked="" type="checkbox"/> Number of levels	Single layer
<input checked="" type="checkbox"/> Number of connections	4

<input type="checkbox"/> Connection method	-
<input type="checkbox"/> Protection Level	IP20
<input type="checkbox"/> Operating temperature range	-40~+105°C
<input type="checkbox"/> Insulation material	PA66
<input type="checkbox"/> Insulation material group	I
<input type="checkbox"/> Contact material	Copper alloy
<input type="checkbox"/> Contact plating	Sn,Plated
<input type="checkbox"/> Color	Green/Black/Blue/Grey/Orange/Red

Technical data

<input type="checkbox"/> IEC Rated Current	320V
<input type="checkbox"/> IEC Rated Voltage	18A
<input type="checkbox"/> Overvoltage category	III III II
<input type="checkbox"/> Degree of pollution	3 2 2
<input type="checkbox"/> Rated impulse voltage	4.0KV 4.0KV 4.0KV
<input type="checkbox"/> UL Rated Current	15A - 10A
<input type="checkbox"/> UL Rated Voltage	300V - 300V
<input type="checkbox"/> Conductor cross section rigid	-
<input type="checkbox"/> Conductor cross section flexible	-
<input type="checkbox"/> Conductor cross section flexible,with furrule	-
<input type="checkbox"/> Locking screw Specification	-
<input type="checkbox"/> Locking screw torque	-
<input type="checkbox"/> Fixed Screw Specification	-
<input type="checkbox"/> 固定螺钉扭矩	-

<input type="checkbox"/> Stripping length	-
<input type="checkbox"/> Use group	B/C/D
<input type="checkbox"/> Rated cross section	-

Commercial data

<input type="checkbox"/> Order No	MC-PA5.0H04-F-0002
-----------------------------------	--------------------

Ningbo SUPU Electronics Co., Ltd.

Address: No. 150, Xinxing 4th Road, High-tech Industrial Development Zone,
Cixi City, Zhejiang Province, China

Zip code: 315303

Switchboard: +86 574-63288158

Fax: +86 574-63288170

E-mail:supucontact@supu.cn

Service Hotline: 400-626-6336



Wechat