

Product Type: Push-in spring terminal

Product Name:TP4-4-PE

Product Description: Connection method:Push in connection,Number of connections:4,Number of levels : 1,Rated cross section:24-10AWG

Product Size

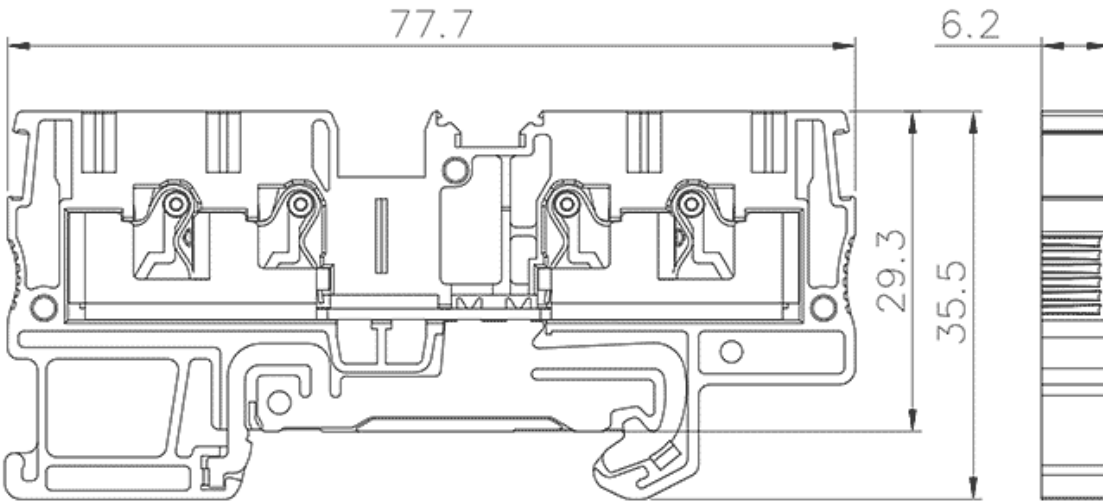

Parameters

☞ SUPU ID	TP4-4-PE
☞ Width	6.2mm
☞ Number of levels	1
☞ Number of connections	4

☞ Connection method	直插弹簧接线
☞ Protection Level	IP20
☞ Insulation material	PA66
☞ Insulation material group	I
☞ Contact material	Copper alloy
☞ Contact plating	Sn,Plated
☞ Ambient temperature (operation)	-40°C~105°C
☞ Ambient temperature (assembly)	-5°C~70°C
☞ Ambient temperature (storage)	-25°C~60°C
☞ Permissible humidity (storage/transport)	30%~70%

Technical data

☞ IEC Rated Current	/
☞ IEC Rated Voltage	/
☞ Overvoltage category	III
☞ Degree of pollution	3
☞ Rated impulse voltage	8KV
☞ UL Rated Current	/
☞ UL Rated Voltage	/
☞ Conductor cross section rigid	0.2-6mm ²
☞ Conductor cross section flexible	0.2-4mm ²
☞ Conductor cross section flexible,with ferrule	0.2-4mm ²
☞ Stripping length	12mm
☞ Use group	/

Commercial data

Ningbo SUPU Electronics Co., Ltd.

Address: No. 150, Xinxing 4th Road, High-tech Industrial Development Zone,
Cixi City, Zhejiang Province, China

Zip code: 315303

Switchboard: +86 574-63288158

Fax: +86 574-63288170

E-mail:supucontact@supu.cn

Service Hotline: 400-626-6336



Wechat